



ELROND
KOMPONENT AB

NY ⚡

Universalklämma

för anslutning av tråd eller plattjärn till armeringsjärn

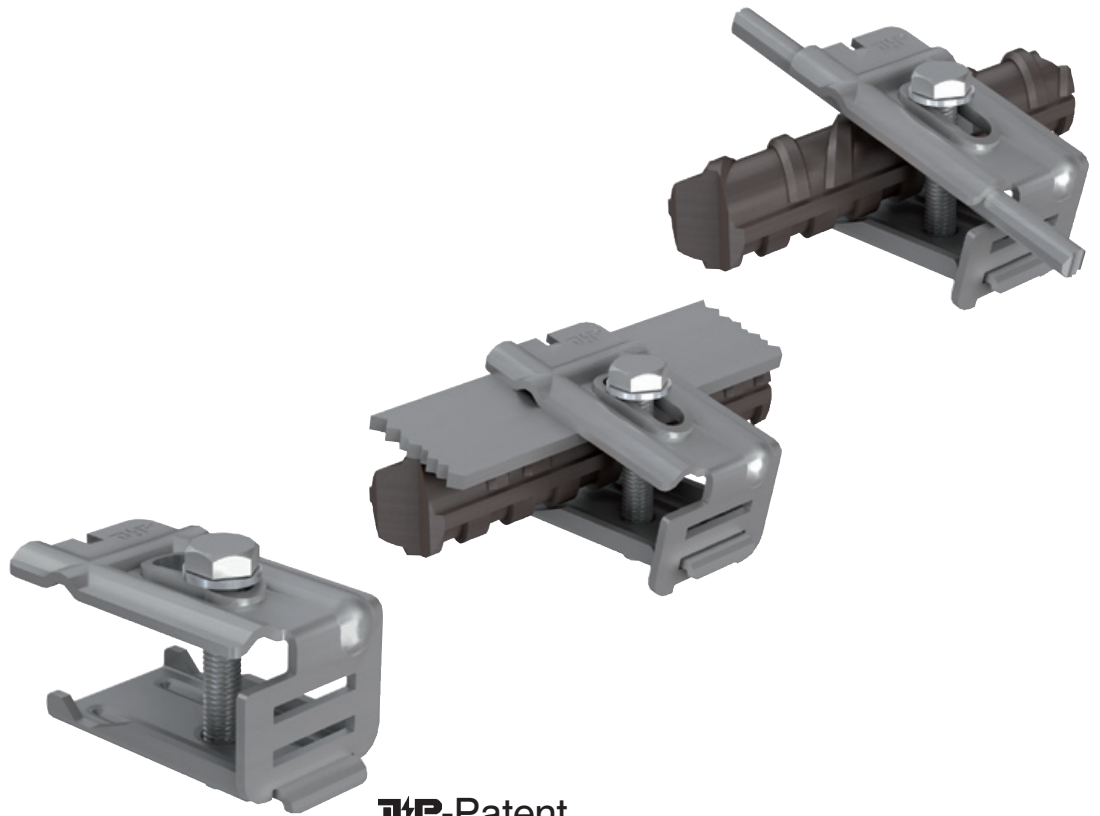

Fördelar:

- Endast en skruv M10 (storlek 17).
- Längs-, tvärs eller sned anslutning.
- Enkel och snabb ändring av klämområde.



Universalklämma **NY!**

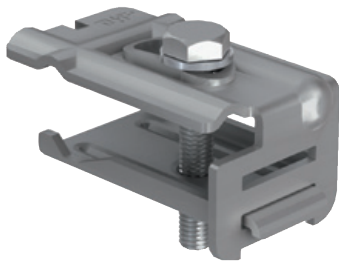

Art nr. 111 699

ES-klämma, för anslutning av plattjärn eller lina mot armeringsjärn. Inklusive bricka DIN 125 A 10,5 V2A.

Specifikation	armering	passar jordning rund eller platt	förp	art.nr.	E-nr.
Stål/förzinkad	ø 10 - 40 mm	ø 8-10 / platt 30 - 40 mm	25	111 699	06 835 74 NY!

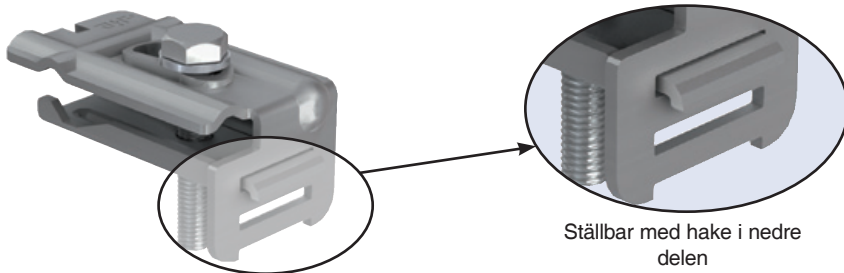

Ställbar med hake i nedre delen

Exempel:



ø 8-10 / ø 12 mm

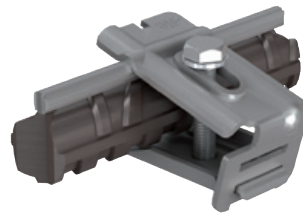

ø 8-10 / ø 28 mm

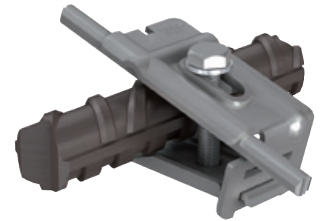

ø 8-10 / ø 28 mm

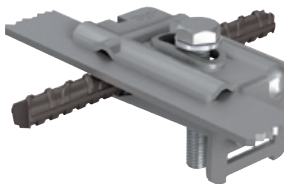

30 x 3,5 / ø 12 mm

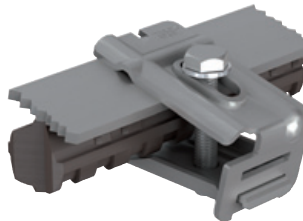

40 x 5 / ø 28 mm

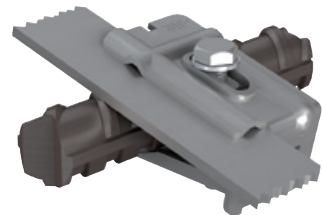

40 x 5 / ø 28 mm

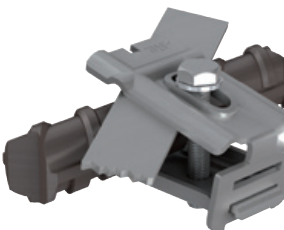

30 x 3,5 / ø 28 mm